

# EZ Series Tubular Skylight

## Rigid and Flex Tubular Skylights Installation Instructions

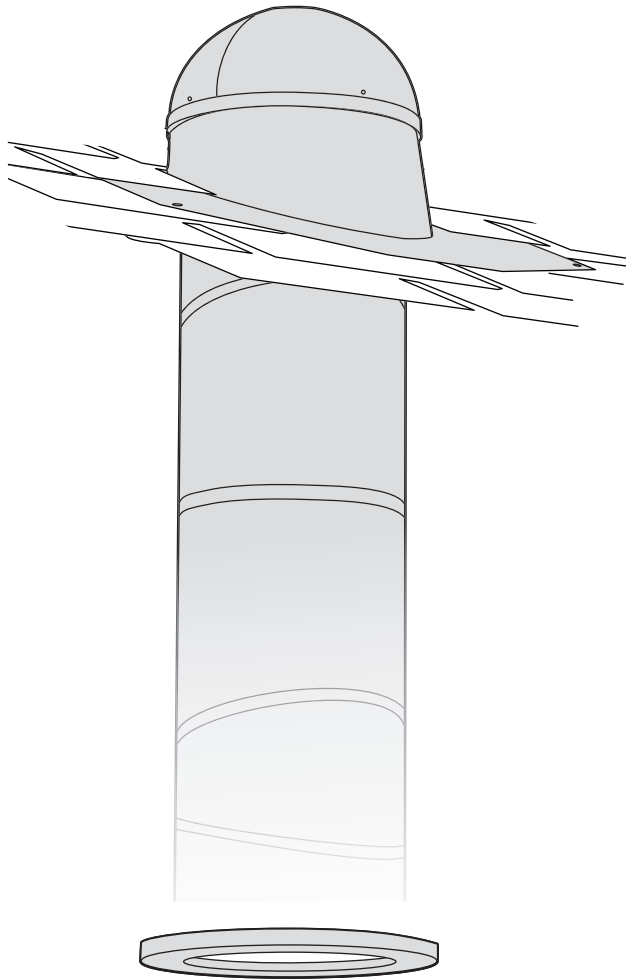

### **Important**

Be sure to first read through and then follow completely all step-by-step instructions. This will help to insure proper installation and functionality. Expect installation to take from 1 to 3 hours.

# Section-i

## What You Need To Know

### REVIEW THIS INFORMATION PRIOR TO BEGINNING INSTALLATION

These instructions have been designed to help install your Kennedy Skylights Tubular Skylight easily and safely. We've included a parts list, list of tools required, installation instructions for a variety of ceiling types, handy tips, and safety precautions. Please read these instructions thoroughly before installing your Kennedy Skylights Tubular Skylight. Pay particular attention to the assembly diagrams, assembly order, and part names. Identify and organize all parts before assembly. Make a list of the tools and components you will need for each installation location. Following these instructions carefully will greatly enhance your ability to install your tubular skylight and enjoy flawless performance for many years.

#### Caution

The tubular skylight is not designed to hold your weight or the weight of tools or other objects. Walking/placing objects on the skylight could cause personal injury and property damage. A damaged skylight should be repaired immediately.

For safe installation and use, do not deviate from these installation instructions.

#### Warning:

Working on a roof is potentially dangerous but you can significantly reduce the risk by following these precautions:

- Never work in wet, windy or cold conditions. Roofing materials can be slippery when wet; asphalt shingles are brittle when cold and may crumble underfoot. Plan your installation for a calm, dry day.
- Wear shoes with slip-resistant soles.

## **WARNING**

**POTENTIAL FIRE HAZARD.** After removing the film lining from the interior of tube shaft, a reflective inner surface is created. **DO NOT** leave tube shaft components unattended or exposed to direct sunlight prior to full installation. Exposed surfaces may catch fire or incur heat damage as a result of focused sunlight until the tube shaft is fully installed with diffuser in place.















#### Safety information:

- Wear safety glasses and work gloves when using power tools.
- Use protective work gloves while handling tube sections to protect hands from sharp edges.

# Section-ii

## Tools & Parts Identification

### TOOLS

-  Carpenter Pencil
-  Claw Hammer
-  Coat Hanger Wire
-  Flat Pry Bar
-  Ladder
-  Metal Shears
-  Phillips Screwdriver
-  Plumb Line
-  Power Drill
-  Power Saw
-  Safety Equipment
-  Measuring Tape
-  Non-Curing/Non-Hardening Roof Sealant (Not provided in kit)
-  Exterior Silicone (Not provided in kit)

**NOTE**  
Read through the section specific to your roof for additional parts and tools.

### PARTS

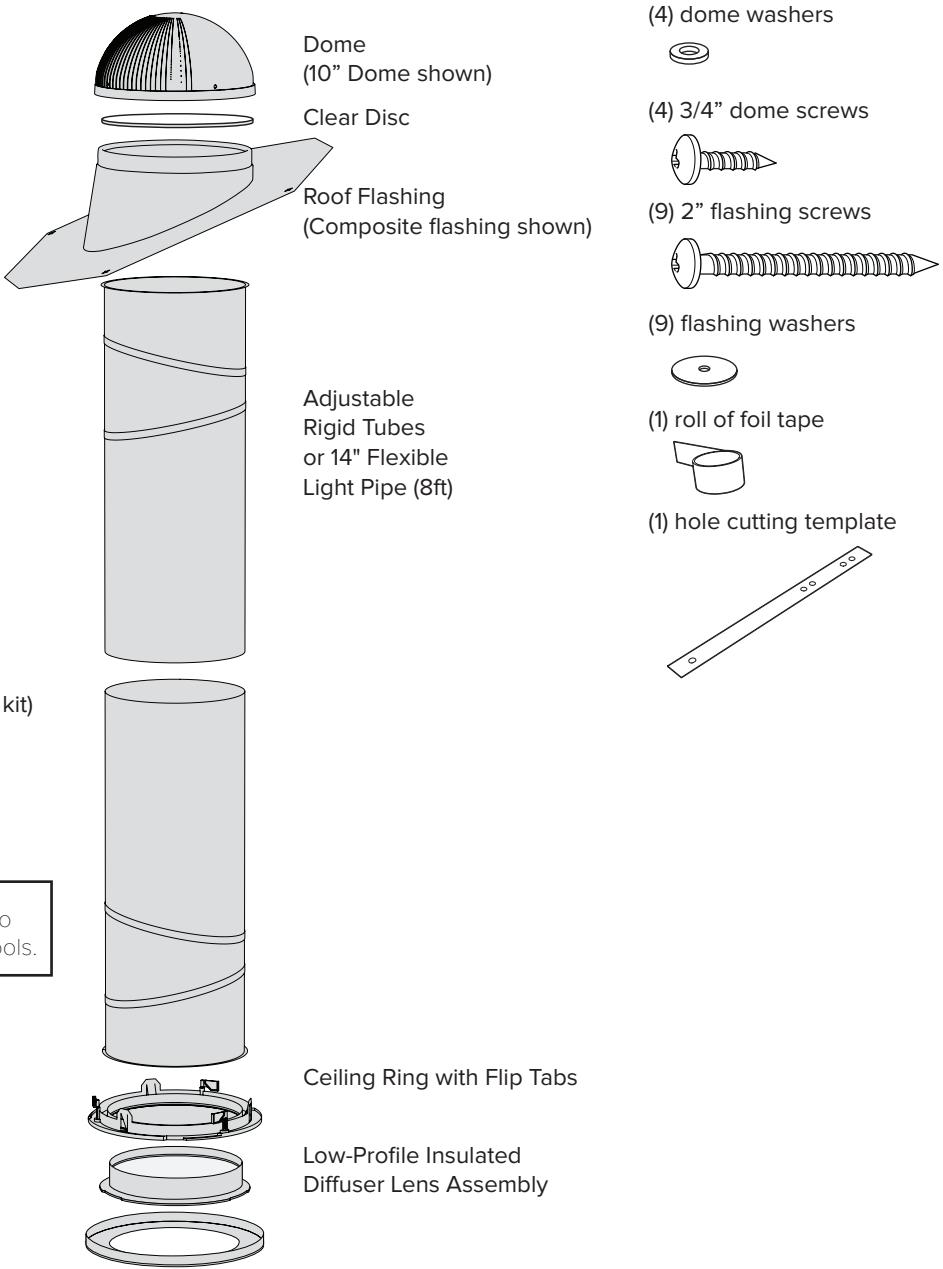

# Section-1

## Determine The Desired Position Of The Tubular Skylight In The Ceiling

### TOOLS & PARTS

-  Carpenter Pencil
-  Claw Hammer
-  Coat Hanger Wire
-  Measuring Tape
-  Phillips Screwdriver

These instructions outline the step-by-step process to install an Kennedy Skylights Tubular Skylight. Before starting, review all instructions and become familiar with the parts shown on the previous page.

#### SPECIAL NOTES

- Always use safe procedures.
- Wear safety glasses when working with tools.
- Check all measurements before cutting or drilling.
- It is helpful to have a second person assist during installation.

- ① Using a stud finder or hammer, find a location between the ceiling joists. Push a screwdriver or nail through the desired position.

Cut and insert a section of coat hanger wire through the hole. This will make it easier to identify the hole location in the attic.

#### NOTE

Refer to Pre-Installation Checklist for tube location tips in section i.

- ② In the attic, locate the coat hanger wire. Adjust its location, centering the opening for the tube between the framing members. Check wire visibility in the ceiling below as well as from the hole that will be cut in the roof.

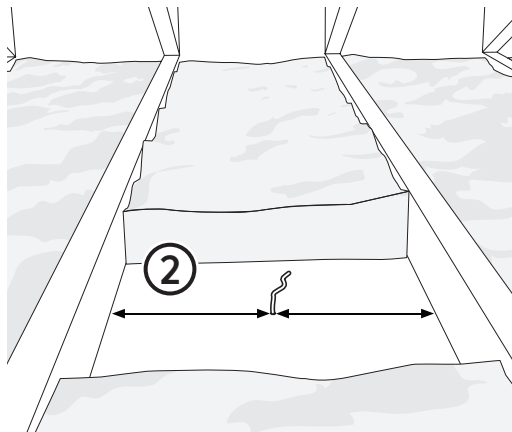
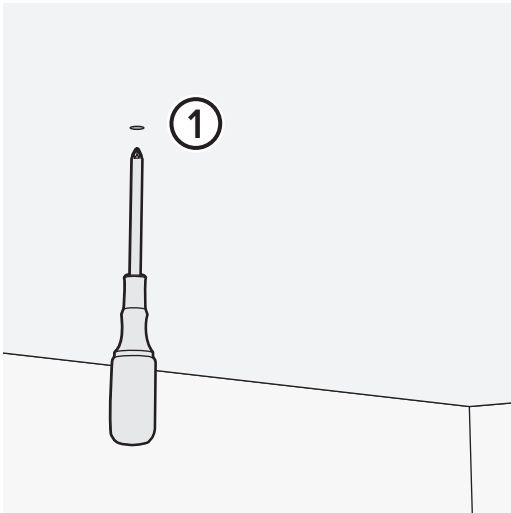

# Section-2

## Locating The Roof Position

### TOOLS & PARTS

-  Carpenter Pencil
-  Claw Hammer
-  Ladder
-  Measuring Tape
-  Phillips Screwdriver
-  Plumb Line
-  Safety Equipment

- 1 Straight Tube Installation**  
In the attic, use a plumb line to find a straight location from the ceiling hole to the roof location. Center the opening for the tube between the framing members. Drive a nail up into the roof deck and through the shingles.
  
- 2 Angled or Flex Tube Installation**  
In the attic, if there are obstructions at the roof location (valleys, wires, pipes, ducts, framing, etc.), adjust tubes up to a combined 45° angle to find a path that avoids interference. Center the opening for the tube between the framing members. Drive a nail up into the roof deck and through the shingles.

**NOTE**  
Trial-fitting your tubing will help in determining adjustability and need for additional extensions.

Straight Tube Installation

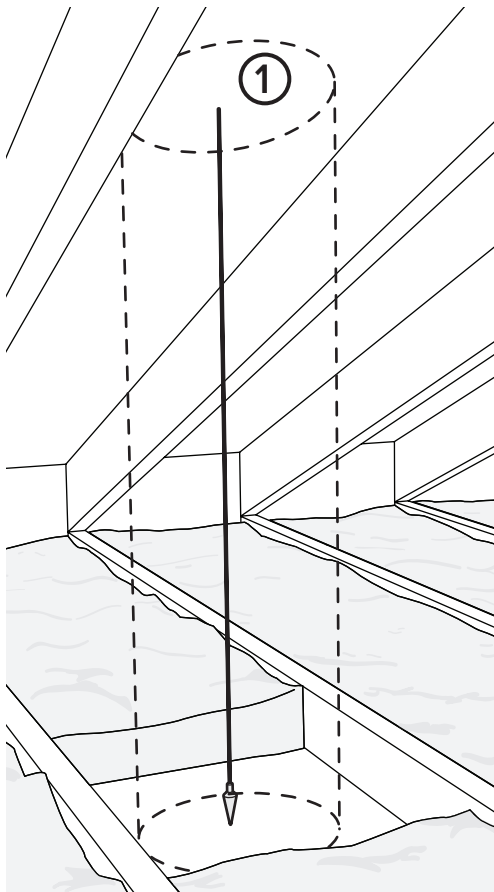

Angled or Flex Tube Installation

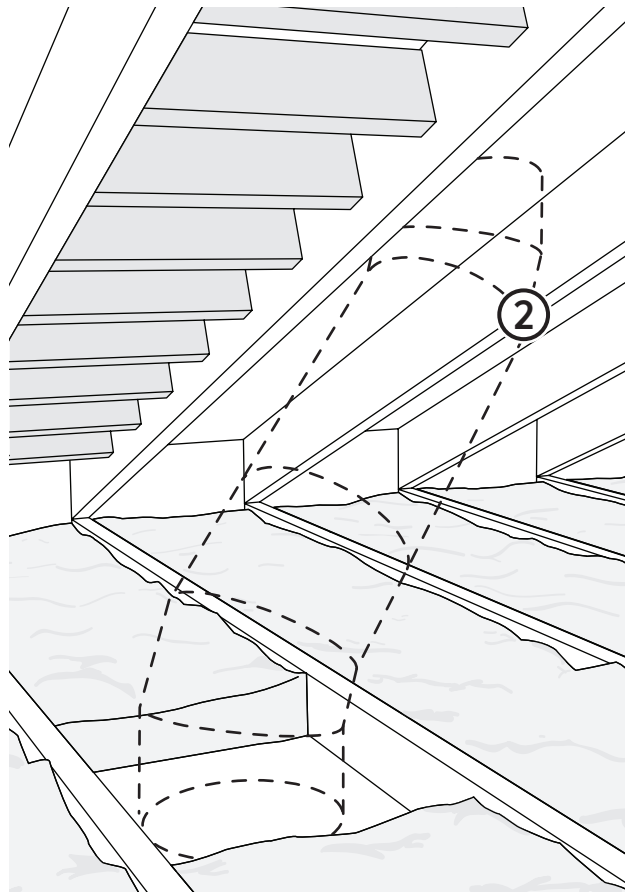

## Section-3

### Prepare The Components

#### TOOLS & PARTS



Adjustable Tubes



Hole Cutting Template

- 1 Remove protective film from inside all tubes.

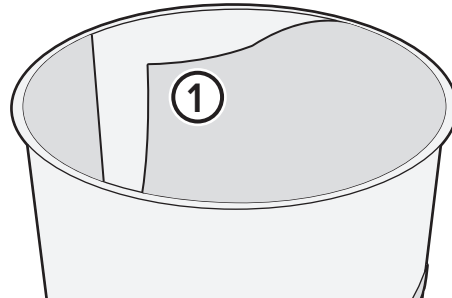

### WARNING

**POTENTIAL FIRE HAZARD.** After removing the film lining from the interior of tube shaft, a reflective inner surface is created. **DO NOT** leave tube shaft components unattended or exposed to direct sunlight prior to full installation. Exposed surfaces may catch fire or incur heat damage as a result of focused sunlight until the tube shaft is fully installed with diffuser in place.

#### CAUTION

From the hardware pack, be sure to use the correct hole cutting template for the selected tube size.

10" Template

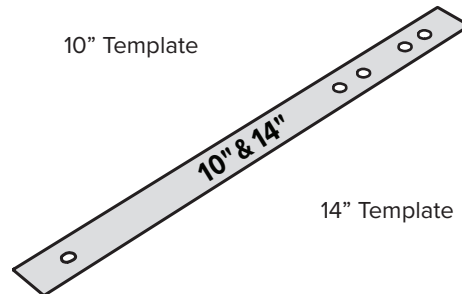

14" Template







#### TIP

It is recommended that you put all of your tools and rooftop components in a box or bag for easy transfer to the roof. See Section 4.

# Section-4a

## On The Roof

### TOOLS & PARTS

-  Carpenter Pencil
-  Ladder
-  Safety Equipment
-  Power Drill
-  Power Saw
-  Hole Cutting Template

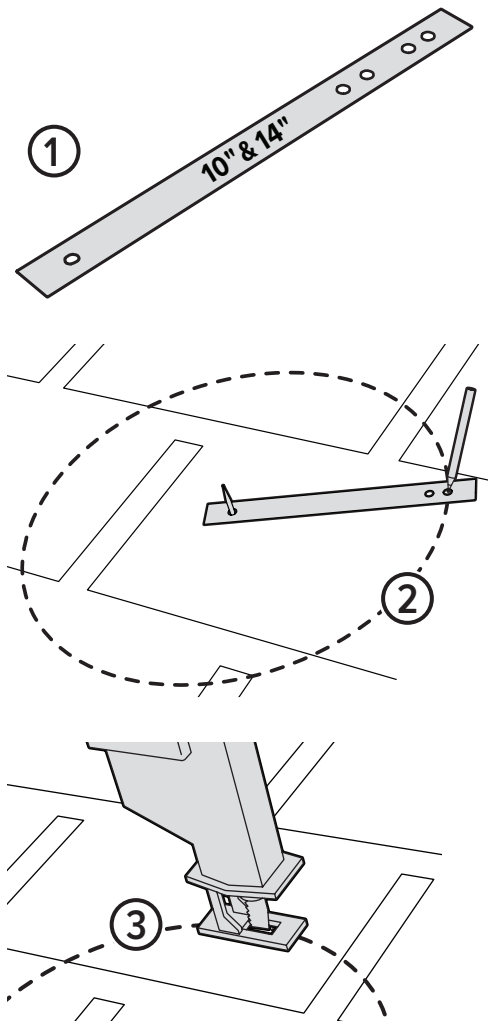

### IMPORTANT

For 14" skylight with 16" on-center rafter spacing, see below.

- ① Select the correct hole cutting template for the tube (10" or 14").
- ② Locate the protruding nail. Use the correct hole-cutting template to trace the diameter of the outer template hole.
- ③ Use a reciprocating/sabre saw to cut the roof hole.

### TIP

Drill a hole inside the traced circle to insert saw blade.





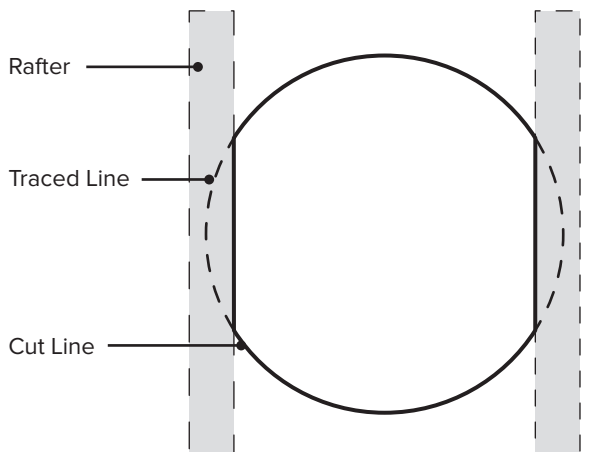





### IMPORTANT

For 14" skylight with 16" on-center rafter spacing, the 14" template will draw a line that overlaps the rafters. Be sure to adjust your cutting angle to avoid cutting into the rafters. (See illustration)



# Section-4b On The Roof

## TOOLS & PARTS

-  Caulk Gun
-  Claw Hammer
-  Flat Pry Bar
-  Ladder
-  Phillips Screwdriver
-  2" Screws
-  3/4" Washers
-  Roofing Sealant
-  Safety Equipment
-  Roof Flashing
-  Top Adjustable Tube

**TIP**  
The vertical seam of the reflective tube should point to the East or West to avoid irregular light patterns in your room.

- ① Use a flat pry bar to carefully break the seals on the shingles upslope above the cut hole. Use a claw hammer to remove nails on the shingles above the cut hole.
- ② Generously apply roof sealant around bottom of flashing. Slide top and sides of roof flashing under top shingles.

**STOP** **IMPORTANT**  
For short shaft cathedral style installation see Section 10. Do not install dome yet.

- ③ Slide Top Adjustable Tube (pink label) into the flashing to check for proper alignment.
- ④ Secure flashing to roof with 2" Flashing Screws and Washers. For aluminum flashing (Both Spun Severe Weather & Formable. See images on pg. 4), use 9 screws & washers in an evenly spaced, circular pattern around the 10" or 14" hole. The circular pattern should be a 21" diameter for the 10" unit and a 24" diameter pattern on the 14" unit.  
For injection molded flashing, use 8 screws and washers in the preformed holes for the 10" and 14" unit.  
Seal screw heads with roof sealant.  
Spun aluminum flashing does not have pre-drilled holes.

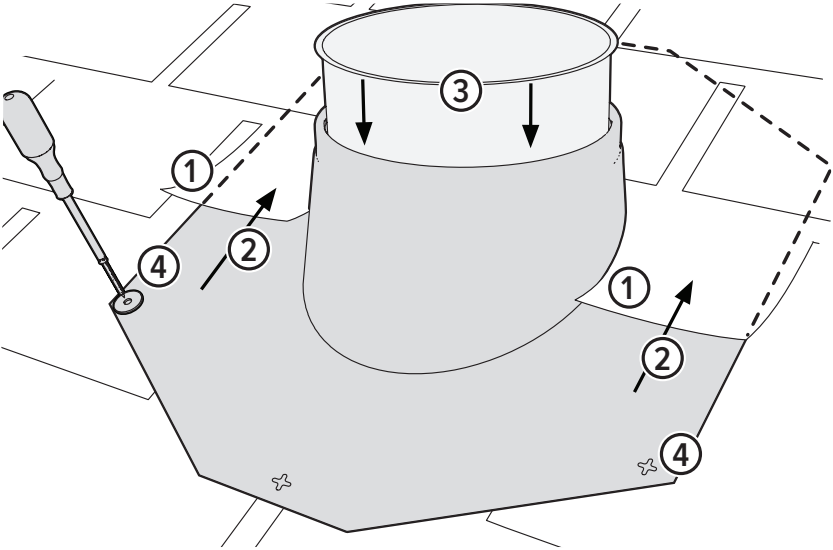
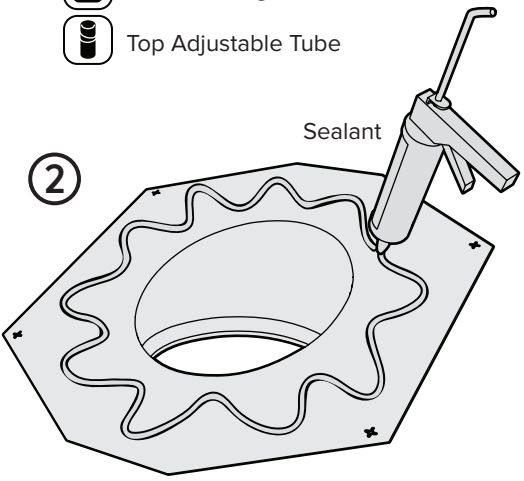











# Section-4c

## On The Roof

### TOOLS & PARTS

-  Ladder
-  Phillips Screwdriver
-  Safety Equipment
-  3/4" Dome Screws
-  Dome Washers
-  Top Adjustable Tube
-  Solar Dome
-  Exterior Clear Pure Silicone

**1** For angled tube installation, reach and adjust the Adjustable Tube so it points to the wire in the ceiling, or adjust the angle of the tube and then insert tube into flashing.

**NOTE**  
Adjust tubes by lightly turning, using one hand on each end.

**2** Place the clear disc on top of the adjustable tube.

**3** Using the 3/4" dome screws and dome washers (dome washers have the rubber backing – rubber backing should face the dome), mount the dome on the flashing aligning the "N" (molded into outer edge of the dome) towards the North.



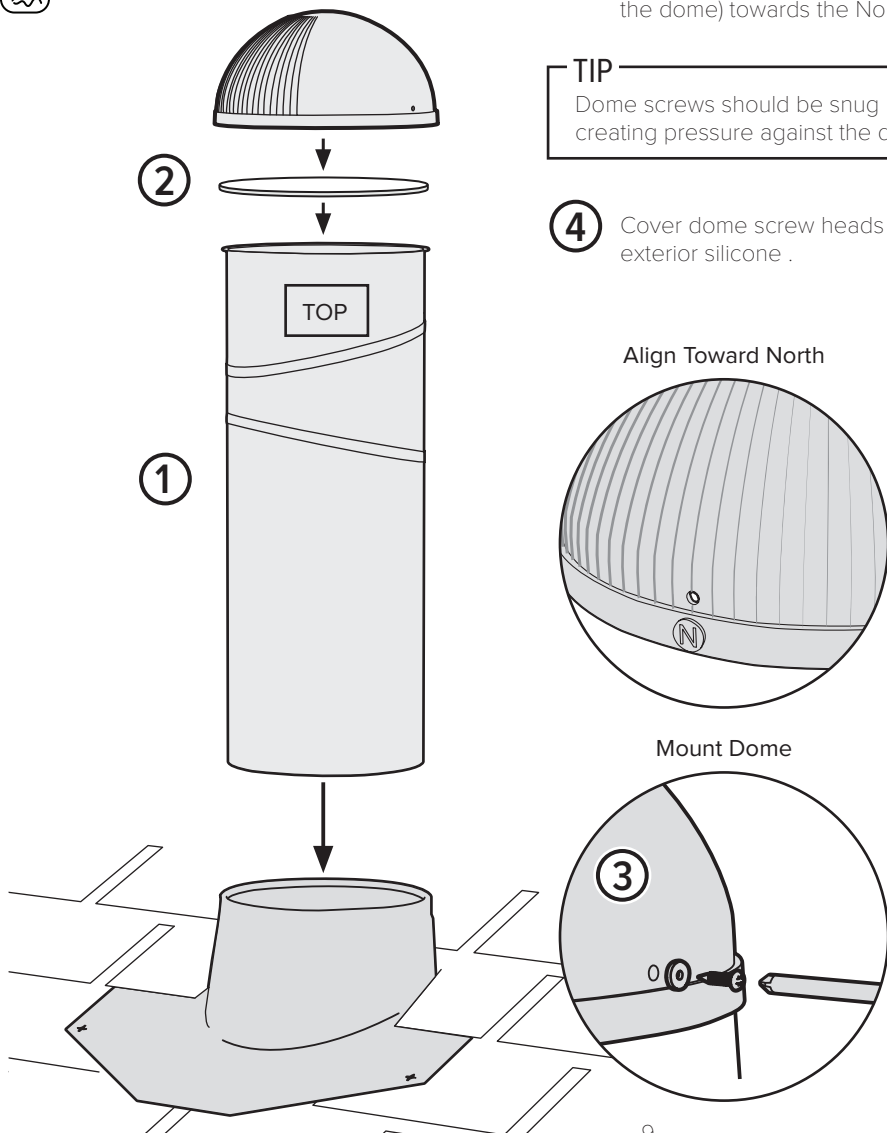

**TIP**  
Dome screws should be snug but do not over tighten creating pressure against the dome.

**4** Cover dome screw heads and washers with an exterior silicone .



## Section-5 Inside The Room

### TOOLS & PARTS

-  Pencil
-  Phillips Screwdriver
-  Power Saw
-  Hole Cutting Template
-  Ceiling Trim Ring

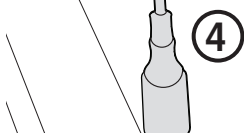
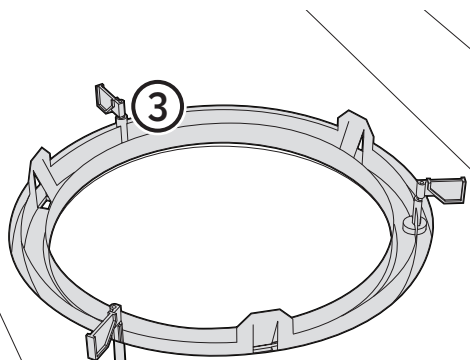
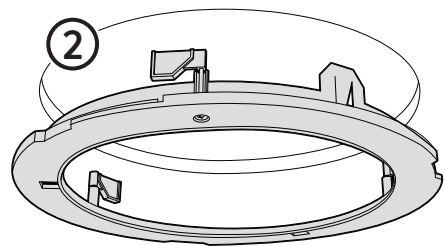
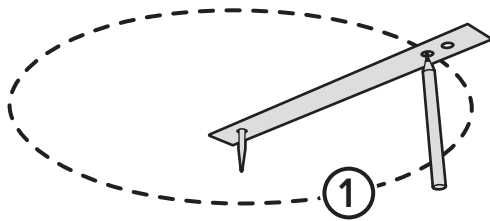

## STOP

### IMPORTANT

For 14" skylight with 16" on-center rafter spacing, see below.

- 1 Using the correct (10" or 14") Hole Cutting Guide for your size tube, and a pencil, locate protruding wire in the ceiling and trace the diameter of the ceiling inner hole using the template marked "A".

### TIP

You may have to drill a hole inside the traced diameter circle to insert saw blade.

- 2 Use a keyhole/drywall saw to cut the hole.
- 3 Slide the Trim Ring up into your ceiling hole. Make sure the flip tabs are turned in. Reach through hole and turn flip tabs out to hold ring in place.
- 4 Secure the ceiling trim ring by tightening the screws.

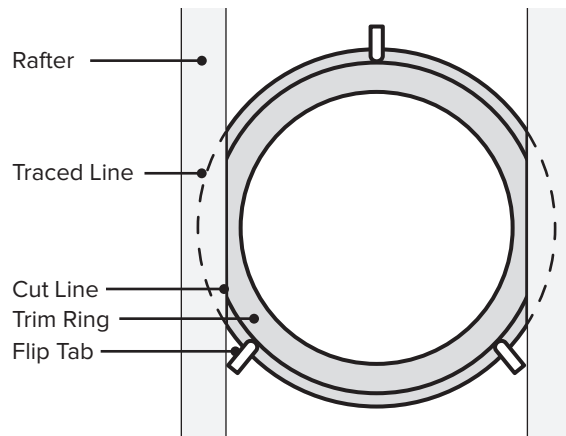

### IMPORTANT

For 14" skylight with 16" on-center rafter spacing, the 14" template will draw a line that overlaps the rafters. Be sure to adjust your cutting angle to avoid cutting into the rafters. (See illustration)



# Section-6 In The Attic

## TOOLS & PARTS

-  Measuring Tape
-  Bottom Adjustable Tube
-  Foil Tape

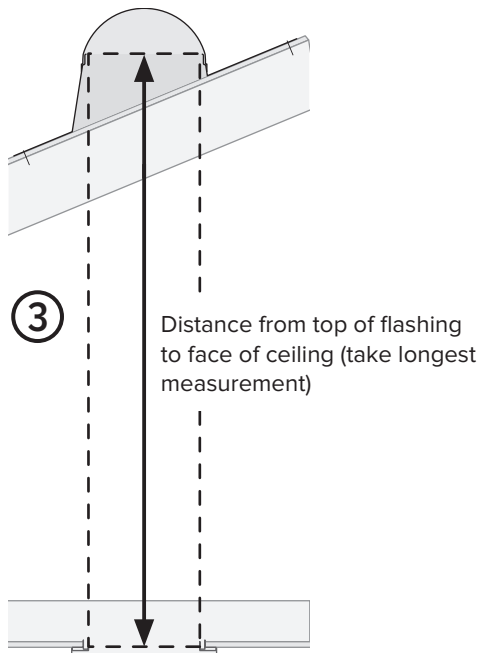
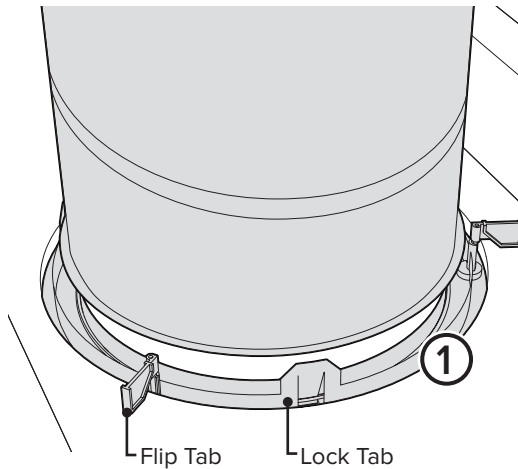

### TIP

The vertical seam of the reflective tube should point to the East or West to avoid irregular light patterns in your room.



### IMPORTANT

At this point, if you purchased a dimmer or combo kit, this is where you reference the dimmer instructions, packaged with the dimmer unit.

- ① Gently set the Bottom Adjustable Tube flange down on the trim ring. Do not snap in place at this time.
- ② If you have an angled installation you will need to twist your Bottom Adjustable Tube (blue label) so it lines up with the Top Adjustable Tube above. (Be sure you have removed the protective film.)

### NOTE

Adjust tubes by lightly turning, using one hand on each end.

- ③ Measure distance from the top of Roof Flashing to ceiling (See illustration) to determine proper trimming of length of tubes. Refer to "Tube Length Chart" in Section 8 for cutting recommendations if you need to shorten the tubes.
- ④ Slide Bottom Adjustable Tube over the outside of Top Adjustable Tube.
- ⑤ Now you can push down to lock the Bottom Adjustable Tube securely into the lock tabs of the ceiling trim ring.
- ⑥ Tape ALL seams securely with Foil Tape to keep dust, moisture, and insects out of the tube.

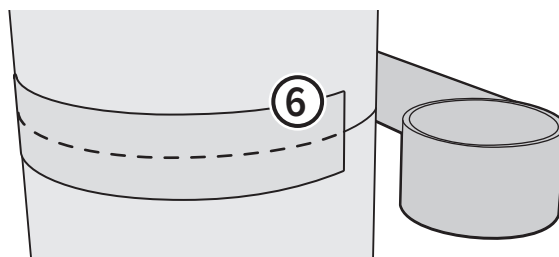







## Section-7

### When Cutting Your Tube...

#### A Rigid Light Pipe Tubes

##### TOOLS & PARTS

-  Carpenter Pencil
-  Metal Shears
-  Safety Equipment
-  Safety Glasses
-  Extension Tubes
-  Gloves

Trimmed Extension Tube

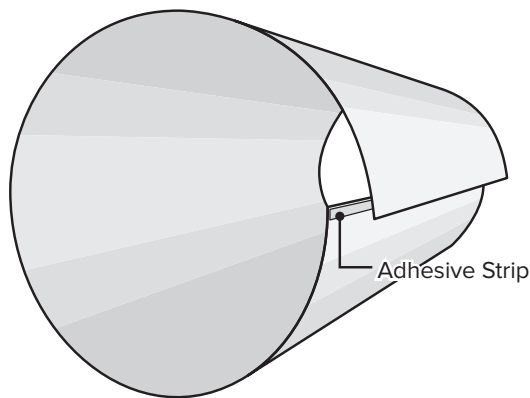

##### IMPORTANT

Once contact is made with adhesive strip on an Extension Tube, parts cannot be repositioned.

- ① Be sure to measure and cut if necessary, before removing adhesive strip and assembling the Extension Tube. Wear gloves when working with sharp edges.

##### TIP

When trimming Extension Tubes, always measure and start from the wide end where tube end diameter = 10" or 14".

- ② After referring to "Tube Length Chart" in Section 8, use metal shears to shorten the Extension Tube. Allow for a 1" overlap at each end where you will connect each tube to another.
- ③ Once Extension Tubes are sized to the proper length, remove tan backing paper from adhesive strip on edge of Extension Tube. Beginning at one end of the Extension Tube, over-lap the edges of the tube/s, aligning the edge of the tube along the crimp on the other side.

(Once contact is made with adhesive strip, parts cannot be repositioned.)

#### B Flex Light Pipe Tubes

- ① Be sure to measure and cut length of flex pipe required from top of flashing to diffuser assembly.
- ② Secure flex light pipe to top transition section of rigid light pipe with supplied hose clamp.

# Section-8 Tube Length Chart

## A Rigid Light Pipe Tubes

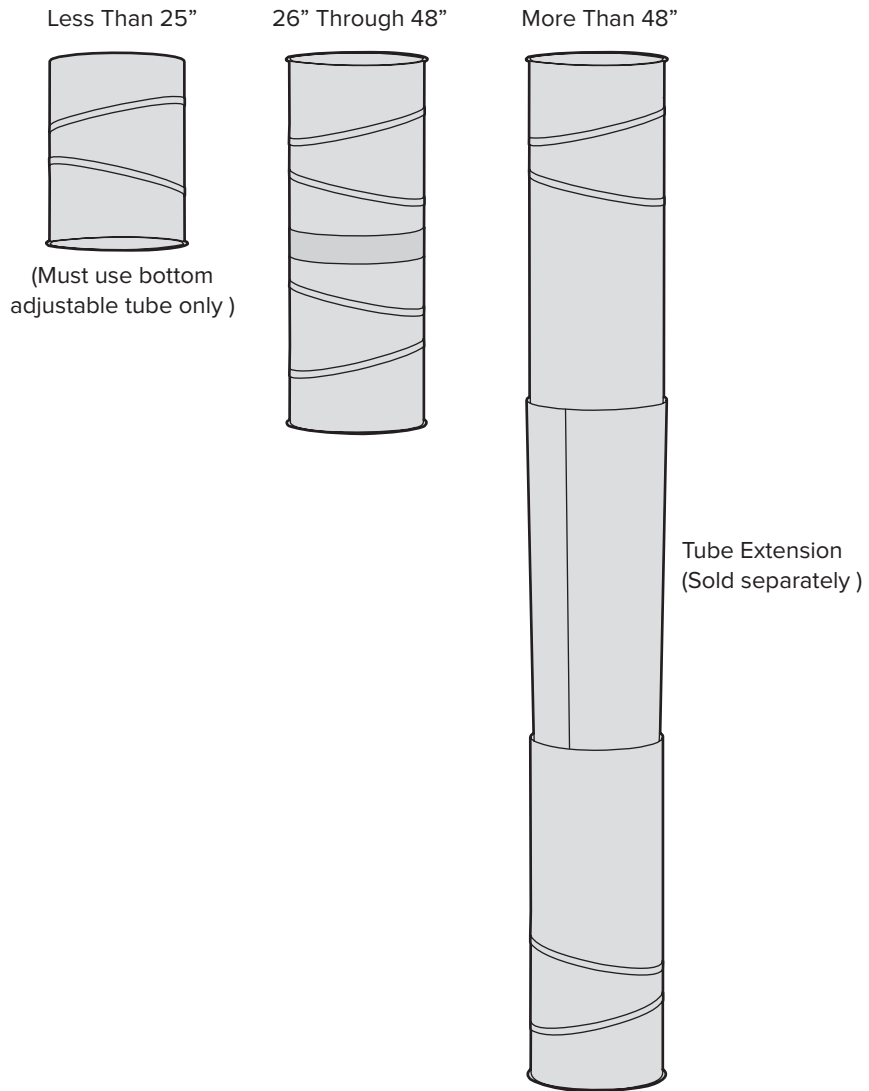

## B Flex Light Pipe Tubes

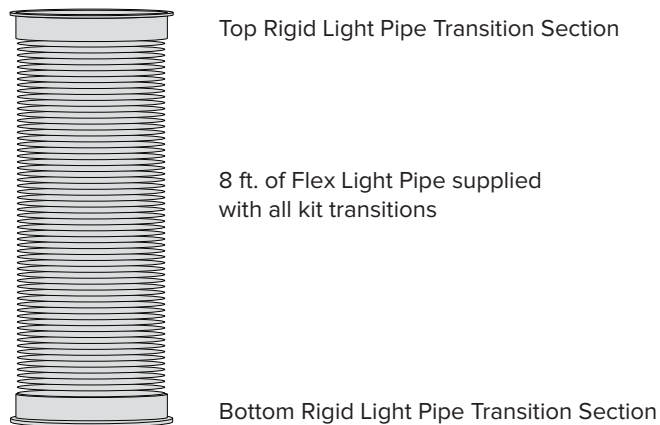

## Section-9

### Inside The Room

#### TOOLS & PARTS



Diffuser Lens Assembly

- 1 Install the Diffuser Assembly by aligning the Diffuser with the three tabs on the Trim Ring. Turn clockwise until snug in place on the ceiling.

#### TIP

Diffuser should be rotated at least through two "clicks". (Full rotation is four "clicks") to attach to Trim Ring.

Installation Complete!

1

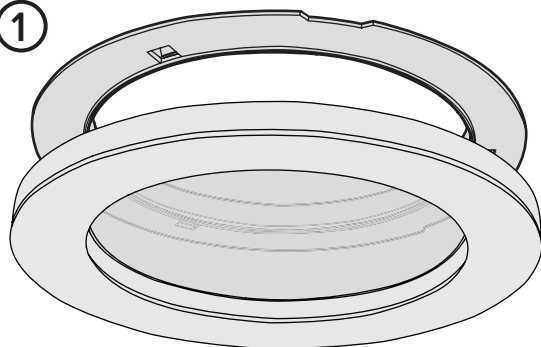





Ceiling Trim Ring

Lens Diffuser & Insulator

# Section-10a

## Cathedral Ceiling/Short Shaft Installation

### TOOLS & PARTS

-  Ladder
-  Pencil/Marker
-  Safety Equipment
-  Shim
-  Bottom Adjustable Tube

Start with regular installation instructions beginning in Section 1.

#### NOTE

The solar powered dimmer will not work with a cathedral ceiling or some short installations due to space restrictions.



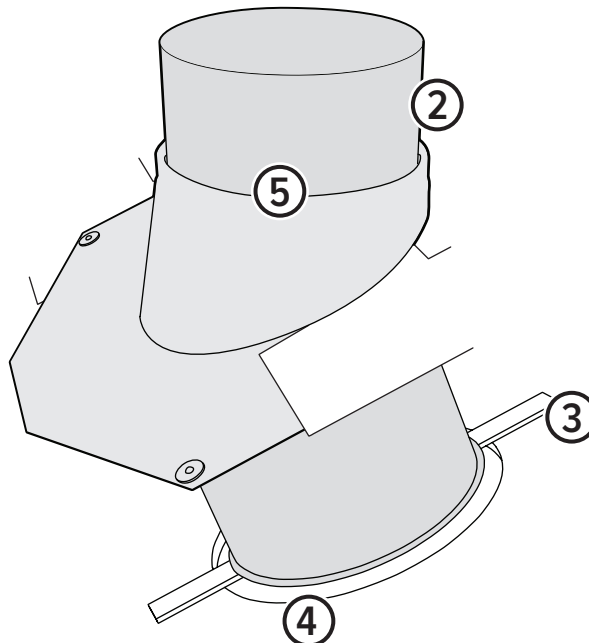
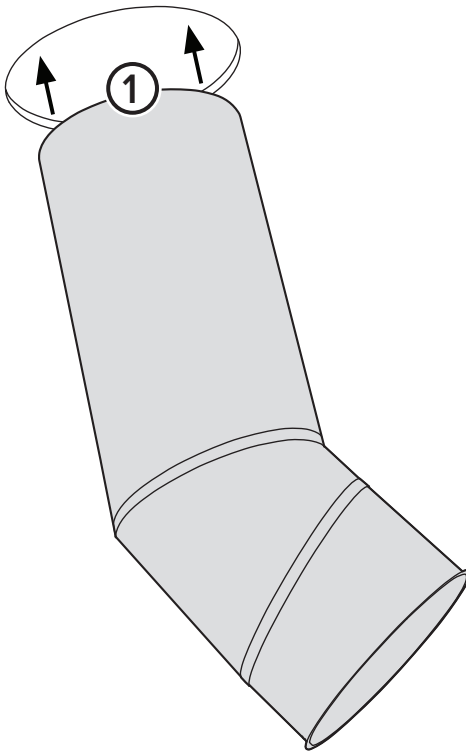



- 1** Place bottom adjustable tube (blue label) (with the flanged end down) through the rough-cut hole in the ceiling.
- 2** Guide the top portion of the tube up through the roof flashing so it protrudes upward through the flashing collar on the roof.
- 3** Place a temporary shim or ruler across the ceiling opening. (Approx 1/8" thick)
- 4** Center the tube over the ceiling cut-out, resting the tube down onto the shim. (The shim will keep the tube from falling through the ceiling.)
- 5** On the roof, mark the protruding tube at the top of the flashing collar with a felt pen. This will indicate where the extra length of tubing must be trimmed off for a short shaft install.



# Section-10b

## Cathedral Ceiling/Short Shaft Installation

### TOOLS & PARTS

-  Gloves
-  Ladder
-  Metal Shears
-  Safety Equipment
-  Bottom Adjustable Tube
-  Ceiling Ring

- 6** At the ceiling, slide the temporary shim out of your way and pull tube section back out of the ceiling.
- 7** Wearing protective gloves, carefully trim away the excess aluminum tubing using your felt pen marks as a guide.
- 8** Remove the protective film from the inside of the tubing.
- 9** Place the tube section back into the ceiling making sure to align and center it inside the roof flashing collar. Place shim back across the cut-out.
- 10** Open the diffuser assembly box and separate the ceiling ring from the diffuser. Install only the Ceiling Ring into the cut-out.
- 11** You can now remove the shim from the ceiling and allow the tube to rest centered over the ceiling ring.

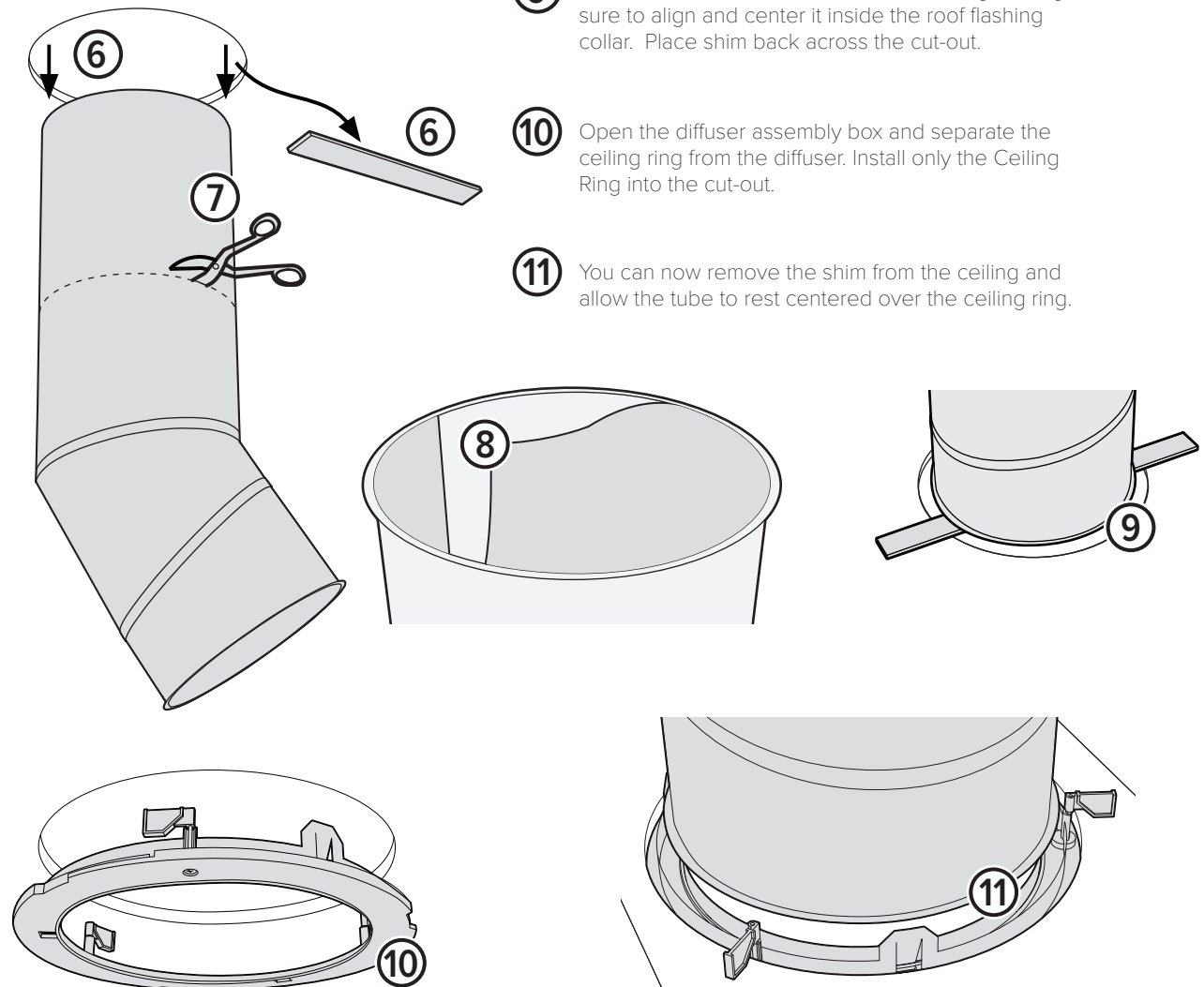











# Section-10c

## Cathedral Ceiling/Short Shaft Installation – On The Roof

### TOOLS & PARTS

-  Ladder
-  Phillips Screwdriver
-  Safety Equipment
-  3/4 Dome Screws
-  Dome Washers
-  Bottom Adjustable Tube
-  Diffuser
-  Solar Lens Dome

**12** Use gloves! The trimmed edge of the tube will be sharp! Carefully press downward on the trimmed end of the tube. It will lock down into the 3 plastic locking tabs located in the Ceiling Trim Ring, securing the tube into the rubber gasket in the ceiling trim ring.

**13** Install the Solar Lens Dome onto the flashing collar. See dome install instructions Section 4c, then return to this page for further instructions.

**14** Rotate the Insulated Ceiling Diffuser onto the Ceiling Trim Ring. See Section 9.

Installation Complete!

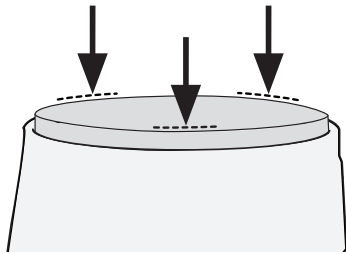

**12**

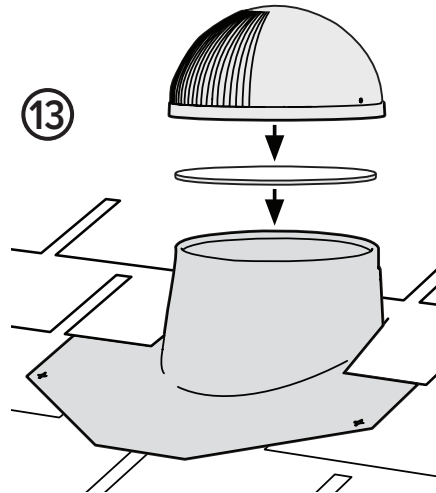
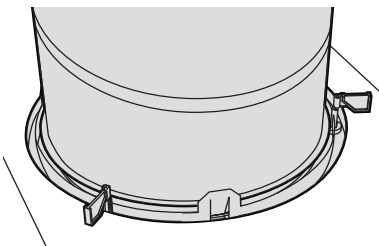

**13**

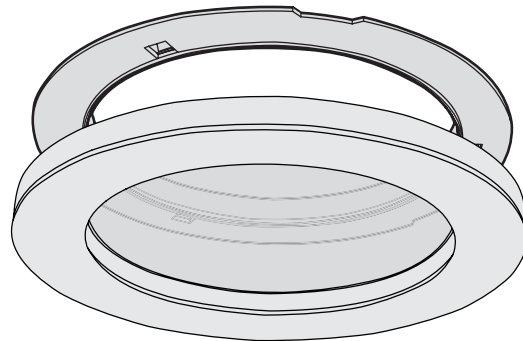





**14**

# Section-11

## Flex Light Pipe Installation

### TOOLS & PARTS

-  (2) 2-1/2" Pan Head Sheet Metal Screws (Not Included)
-  3/32" Bit
-  Drill
-  Phillips Drill Bit

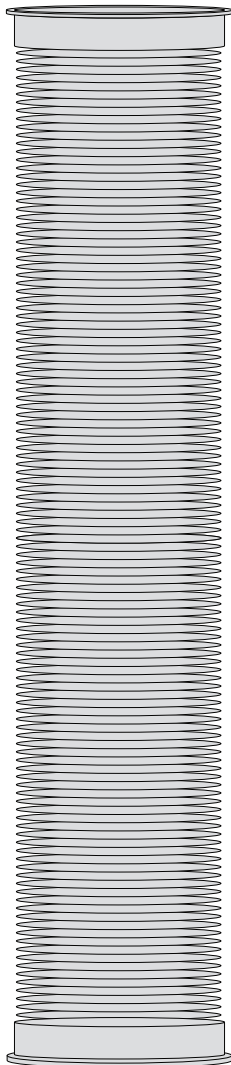

Extension Tube(s)

### Flex Light Pipe Installation

For flex pipe installation, use steps listed below, referring to those listed on previous pages for more specific install data.

- 1** Before going onto roof, cut the flex light pipe to length needed from top of flashing to diffuser assembly. Install one end of the flex light pipe onto the top section of the rigid light pipe up to the flange. Secure with the flex pipe with the hose clamp provided.
- 2** On the roof, install the top section of the rigid light pipe with attached flex pipe through the opening of the flashing. The flange of the rigid light pipe should rest on top of the flashing. Secure with self taping screws provided.
- 3** In the attic, stretch the flex light pipe as taught as possible. Secure the flex light pipe onto the bottom section of rigid light pipe with the hose clamp provided. Secure the bottom section of rigid light pipe into the ceiling ring assembly such that the tabs lock it into place.